

TOP VIEW

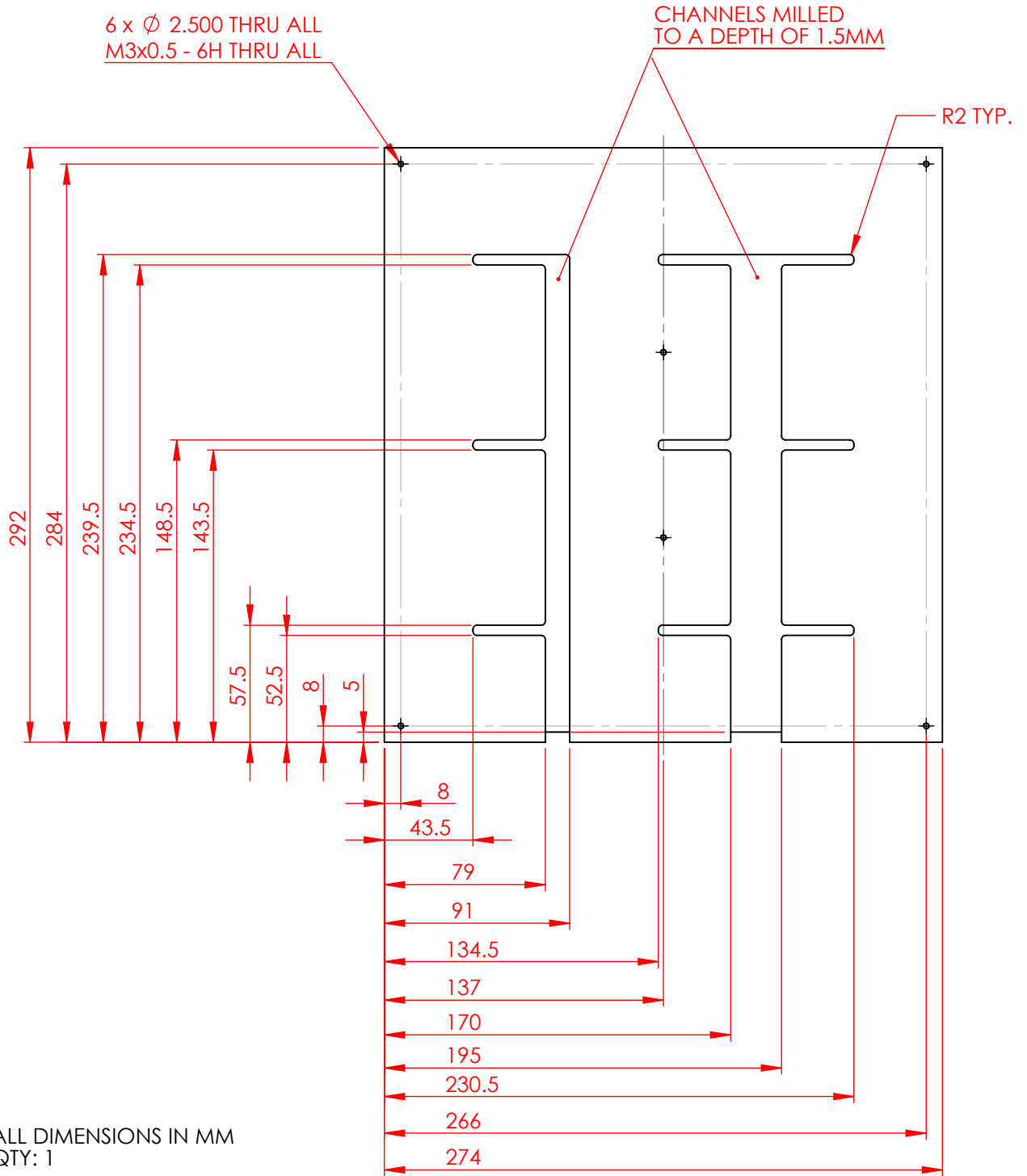

- NOTES:  
 1. ALL DIMENSIONS IN MM  
 2. QTY: 1

UNLESS OTHERWISE SPECIFIED: DIMENSIONS ARE IN MILLIMETERS SURFACE FINISH: TOLERANCES: LINEAR: ANGULAR:				FINISH:		DEBUR AND BREAK SHARP EDGES		DO NOT SCALE DRAWING		REVISION	
DRAWN				NAME		SIGNATURE		DATE		TITLE: <b>MiddleInsulator</b>	
CHK'D											
APPV'D											
MFG											
Q.A						MATERIAL: <b>G-10</b>		DWG NO. <b>AZHF011</b>		A4	
						WEIGHT:		SCALE:1:5		SHEET 1 OF 5	

BOTTOM VIEW

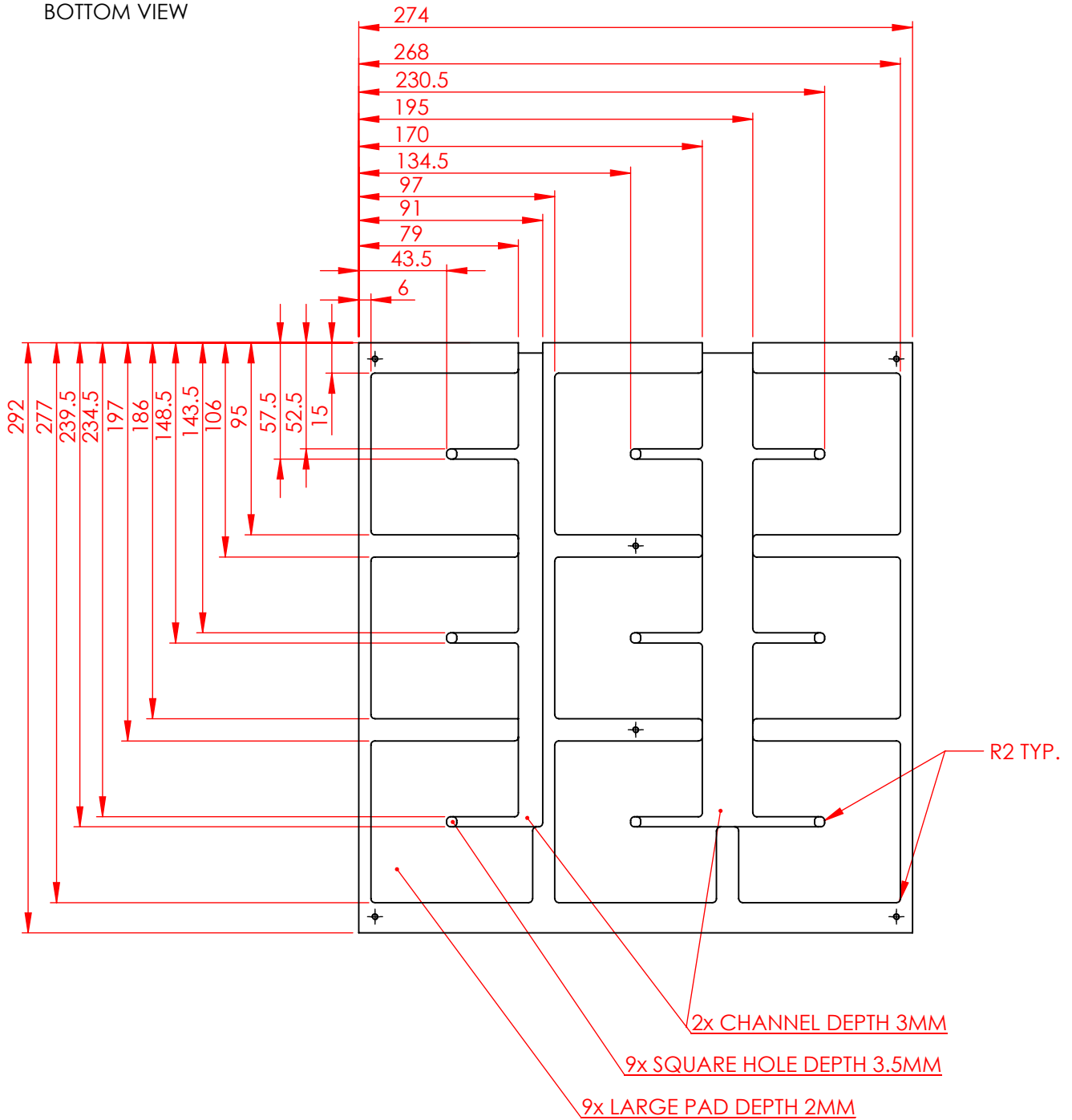

UNLESS OTHERWISE SPECIFIED:  
DIMENSIONS ARE IN MILLIMETERS  
SURFACE FINISH:  
TOLERANCES:  
LINEAR:  
ANGULAR:

FINISH:

DEBUR AND  
BREAK SHARP  
EDGES

DO NOT SCALE DRAWING

REVISION

	NAME	SIGNATURE	DATE		
DRAWN					
CHK'D					
APPV'D					
MFG					
Q.A				MATERIAL:	
				G-10	
				WEIGHT:	

TITLE:	
DWG NO.	AZHF011
SCALE:1:5	SHEET 2 OF 5
	A4

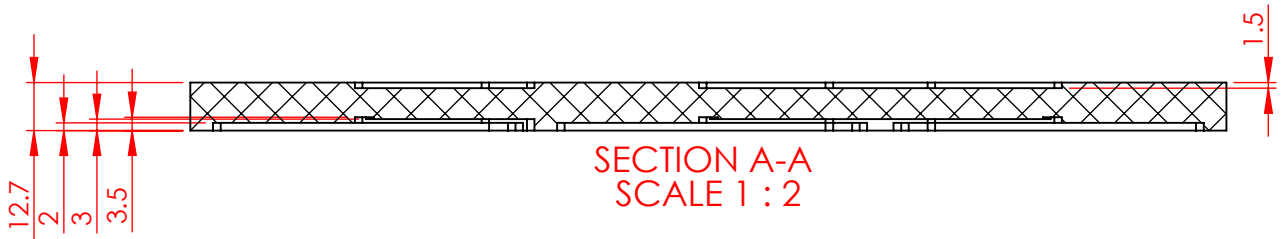
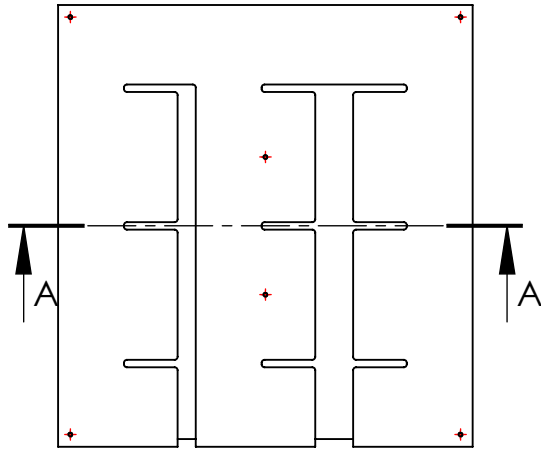

SECTION A-A  
SCALE 1 : 2

NOTES:

1. ALL DIMENSIONS IN MM
2. QTY: 1

UNLESS OTHERWISE SPECIFIED: DIMENSIONS ARE IN MILLIMETERS SURFACE FINISH: TOLERANCES: LINEAR: ANGULAR:		FINISH:		DEBUR AND BREAK SHARP EDGES		DO NOT SCALE DRAWING		REVISION	
DRAWN		SIGNATURE		DATE		TITLE:			
CHK'D									
APPV'D									
MFG									
Q.A				MATERIAL:  G-10		DWG NO.		AZHF011	
						SCALE:1:5		A4	
				WEIGHT:		SHEET 3 OF 5			

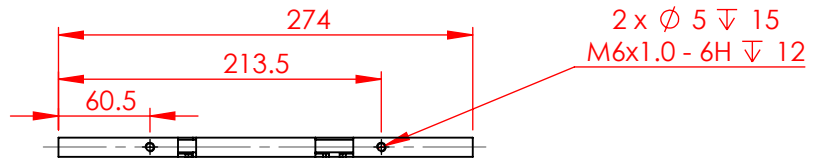

2 x Ø 5 ± 15  
M6x1.0 - 6H ± 12

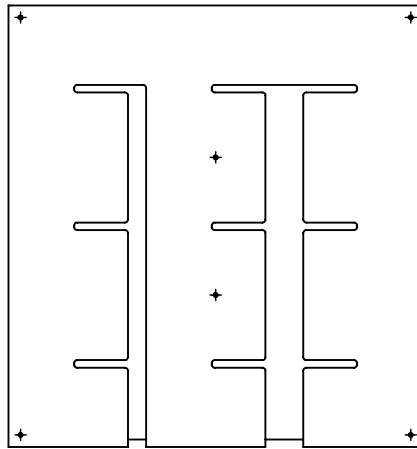
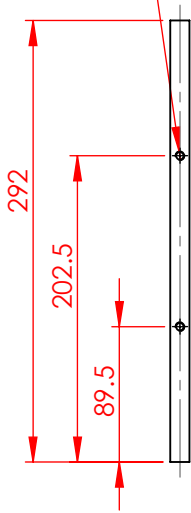

2 x Ø 5 ± 15  
M6x1.0 - 6H ± 12

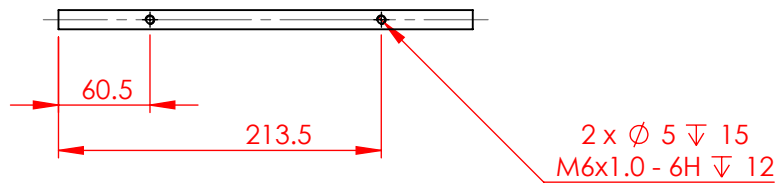
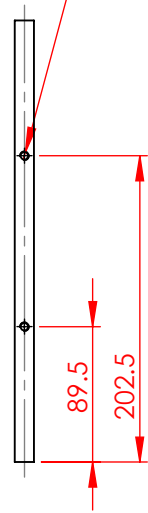

NOTES:

1. ALL DIMENSIONS IN MM
2. QTY: 1

UNLESS OTHERWISE SPECIFIED: DIMENSIONS ARE IN MILLIMETERS SURFACE FINISH: TOLERANCES: LINEAR: ANGULAR:				FINISH:		DEBUR AND BREAK SHARP EDGES		DO NOT SCALE DRAWING		REVISION	
NAME				SIGNATURE		DATE		TITLE:			
DRAWN											
CHK'D											
APPV'D											
MFG											
Q.A						MATERIAL: G-10		DWG NO. AZHF011		A4	
						WEIGHT:		SCALE:1:5		SHEET 4 OF 5	

TOP VIEW

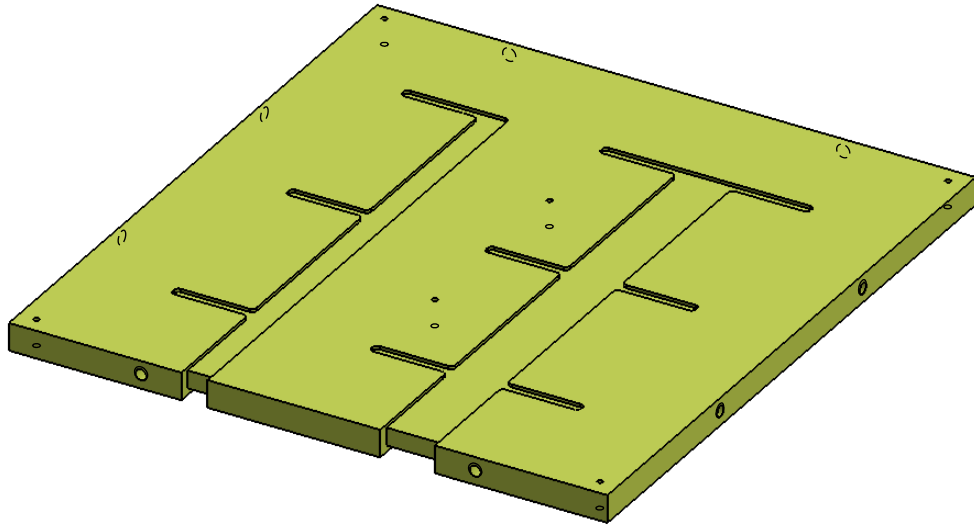

BOTTOM VIEW

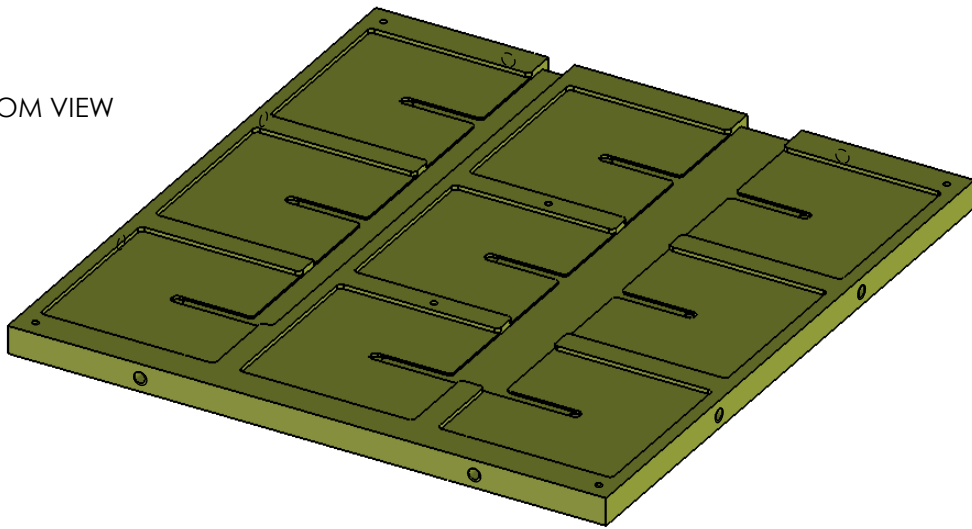

UNLESS OTHERWISE SPECIFIED: DIMENSIONS ARE IN MILLIMETERS SURFACE FINISH: TOLERANCES: LINEAR: ANGULAR:				FINISH:		DEBUR AND BREAK SHARP EDGES		DO NOT SCALE DRAWING		REVISION	
DRAWN				SIGNATURE		DATE		TITLE:			
CHK'D											
APPV'D											
MFG											
Q.A						MATERIAL:		DWG NO.		A4	
						WEIGHT:		SCALE:1:5		SHEET 5 OF 5	
								<b>AZHF011</b>			